

A E N O

C R E A T I N G T H E F U T U R E



AENO™ Handheld Garment Steamer Operation Manual

Model AGS0001, AGS0003

Version 1.0.6 | 21.04.2023

Introduction

This operation manual contains a detailed description of AENO™ Hand-held Garment Steamer, as well as instructions for its preparation for work, operation, and maintenance.

Copyright

Copyright © ASBISc Enterprises PLC. All rights reserved.

The AENO™ trademark belongs to the ASBIS GROUP OF COMPANIES (hereinafter "ASBISc").

All trademarks, trade names, logos and other symbols mentioned herein are the property of their respective owners.

The material presented under the name AENO™ and contained in this manual is protected by international and local laws, including copyright and other related rights laws.

Any references to names of other companies, brands and equipment in this document are for the sole purpose of explanation and description of the devices and do not violate anyone's intellectual property rights.

Any reproduction, copying, publication, further distribution or public display of materials presented herein (in whole or in part) is only permitted after appropriate written permission from the copyright holder.

Any unauthorized use of this manual materials may subject the user to civil liability and criminal prosecution under applicable law.

Responsibility and technical support

This document was prepared in accordance with all necessary requirements and contains detailed information on the operation of the device, which is valid at the date of the device's issue.

This Installation and Operation Manual and the Quick Start Guide are an integral part of the device and should always be available to the user as reference documentation.

ASBISc reserves the right to modify the device and to make additions and changes to this document without prior notice to users and shall not be liable for possible

negative consequences resulting from the use of an outdated version of the document, nor for any possible technical or typographical errors, omissions, or incidental or consequential damages that may result from the transmission of this document or the use of the device.

In the event of discrepancies in the language versions of the document, the Russian version of this manual shall take precedence.

ASBISc does not guarantee with respect to the material herein, including but not limited to merchantability and suitability for a particular purpose.

If you have any technical questions, please contact your local ASBISc representative or Technical Support department at aeno.com. The most common problems encountered are described in the section 7, "Troubleshooting" of this document.

You can download the latest version of this manual at **aeno.com/documents**.

User information, including personal data, is protected from unauthorized access and disclosure in accordance with GDPR requirements. You can read the Privacy Policy at **aeno.com/privacy-policy**.

Standards compliance



The device is CE certified and meets the requirements of the following European Union directives:

- Electromagnetic Compatibility Directive 2014/30/EU;
- Low Voltage Directive 2014/35/EU;
- Directive 2009/125/EU on ecodesign requirements for energy-related products;
- Regulation 1275/2008/EU on standby and non-operating power consumption;
- Regulation 801/2013/EU on the ecodesign of energy-using products.



The device has passed all assessment procedures established in the technical regulations of the Customs Union and complies with the standards of the Customs Union's member states.



National Mark of Conformity of Ukraine, indicating that the device meets all required technical regulations.



The symbol of the crossed-out trash can is used to mark electrical and electronic equipment and indicates its separate collection.

The symbol is given in accordance with the Waste Electrical and Electronic Equipment (WEEE) * Directive 2012/19/EU and indicates that this equipment requires separate collection at the end of its life and must be disposed of separately from unsorted municipal waste.

To protect the environment and human health, dispose of used electrical and electronic equipment according to approved safe disposal guidelines.

	AE	AM	BG	CN	CZ	DE	EE	ES	FR
	GB	GE	GR	HR	HU	IT	KZ	LT	LV
	NL	PL	PT	RO	RS	EN	SK	UA	UZ

* See Section 8 "Glossary" for an explanation.

Limitations and warnings

Please read the information in this section of the document carefully before you start installing and operating the device.

WARNING!

The warnings, precautions and instructions in this document may not contain all possible hazards. Common sense should be taken into account when using the device.

Warning symbols and signs



Class I protection against electric shock. The symbol means that the device must be individually connected to a special socket with a ground contact



Hot steam. Danger of burns from contact with hot steam and/or heating elements of the device



The device's packaging is recyclable and partially or completely made from recycled raw materials



The packaging of the device can be disposed of along with household waste

Safe use rules

The device is intended for use by persons over 18 years of age.

Persons with disabilities who attained 18 years of age, understand the nature of their actions and are physically capable of operating the device in accordance with this user manual may use the device only under the supervision of a person responsible for their safety.

ATTENTION!

Failure to follow the operating instructions in this manual may result in personal injury or property damage. ASBIS shall not be held liable for any damages resulting from failure to observe the device operating instructions.

1. The device is designed for use in the home, offices and other similar environments. Do not use it for industrial purposes.
2. **The device must be out of reach of children and animals.**
3. Do not leave the device near open flames, hot surfaces, or heating appliances.
4. Before connecting the device to the power source, check that the rated voltage indicated in the technical documentation corresponds to the electrical voltage of the socket.
5. Connect the power cord to a grounded socket and disconnect only with dry hands. Do not use an extension cord.
6. **Fill the tank with clean, distilled water only, without the use of detergents.**
7. Before turning the device on, make sure that the water tank is correctly installed and its hole is sealed with the plug.
8. Do not remove the water tank during operation. Do not turn on the steamer if the water tank is empty. This can cause damage to the device.
9. During operation, the surface of the steaming head can get very hot. Handle the device carefully to avoid burns. Do not touch the steaming head during operation and for about an hour after use, until it has cooled down completely. Make sure that children or animals do not touch the hot steaming head.
10. Do not lean the hot steaming head against furniture or other interior elements to avoid damaging them.
11. Before using the device, make sure that the fabric to be flattened is resistant to high steam temperatures (at least 160 °C). Check the care information on the label.
12. Never steam clothes on yourself, other people or animals.
13. The device is designed for use on fabric. Do not use the device on other surfaces such as glass, metal, or wood.
14. **Never point the steam jet at people, animals, plants, electrical appliances, explosive, corrosive or toxic substances.**
15. Place the power cord so that it cannot be accidentally stepped on or stumbled through.
16. Do not place the power cord on anything with a sharp edge and do not place anything on top of the cord.
17. Make sure that the power cord does not hang over the edge of furniture or touch surfaces that can damage the insulation.
18. Do not wrap the power cord around the device.

19. If the power cord is damaged, first de-energize the socket, then unplug the device. The power cord should only be replaced by a service technician.
20. Always remove the plug from the socket after use or before cleaning the device.
21. Allow the device to cool completely (may take up to 1 hour) before cleaning or storing it.
22. Do not use strong chemicals or abrasive materials to clean the device.
23. Use only nozzles or replacement parts recommended or supplied by ASBISc for this model.
24. If the device has fallen into the water, do not touch it under any circumstances and unplug it immediately.
25. Never use a device that has been in water. Have it checked by an authorized service center.
26. If you notice a malfunction, stop using the device immediately and contact the service center.
27. The device and its components should only be repaired by a service center technician. Never try to repair the device yourself.
28. Do not make any modifications to the device or accessories.

Contents

Introduction.....	3
Copyright.....	3
Responsibility and technical support	3
Standards compliance.....	5
Limitations and warnings.....	6
Contents.....	9
1 General description and specifications	11
1.1 Purpose of the device	11
1.2 Technical specifications	13
1.3 Scope of supply	15
1.4 Packaging and labelling.....	16
1.5 Device control panel.....	16
2 Preparing for work and operation.....	18
2.1 Preparing textiles for steaming.....	18
2.2 Preparing the steamer for operation	20
2.3 Operating the device	26
2.4 Auto standby function	28
2.5 Auto shutdown function in case of overheating	29
2.6 Self-cleaning function	30
3 Maintenance	31
3.1 Cleaning the device case.....	32
3.2 Cleaning accessories and components.....	33
4 Warranty obligations.....	34
4.1 AENO service centers	34
4.2 Warranty service procedure	35
4.3 Limitation of liability.....	35
5 Storage, transportation and disposal.....	37
6 Other information	38
7 Troubleshooting	39
8 Glossary.....	40

Figures and tables

Figure 1 – Appearance of the device	11
Figure 2 – Device elements	12
Figure 3 – Scope of supply *	15

Figure 4 – Device control panel	16
Figure 5 – No steaming symbol on the product label	18
Figure 6 – Horizontal and vertical steaming.....	19
Figure 7 – Removing the tank.....	20
Figure 8 – Tank silicone plug in "open" position	21
Figure 9 – MAX mark on the measuring cup	21
Figure 10 – Filling the tank.....	22
Figure 11 – Tank installation	22
Figure 12 – Tank lugs and slots on the device	23
Figure 13 – Nozzle on the steaming head of the device	24
Figure 14 – Pressing the ON/OFF button	25
Figure 15 – Pressing the steam button	26
Figure 16 – Removable brush for the nozzle	28
Figure 17 – Device control panel in standby mode	29
Figure 18 – Cleaning the device case.....	32
Figure 19 – Cleaning the water tank and accessories	33
Table 1 – Specifications.....	13
Table 2 – Scope of supply	15
Table 3 – Buttons and indicators of the device control panel.....	17
Table 4 – Operating mode selection.....	27
Table 5 – Typical problems and solutions	39

1 General description and specifications

1.1 Purpose of the device

The AENO™ Handheld Garment Steamer is designed to remove creases and irregularities in fabric with a powerful stream of steam. It is a portable device that can be used to quickly iron clothes, curtains, coats, bedspreads and other textiles *. After steaming, the fibers of the fabric are flattened and become more voluminous. This has a positive effect on the texture of the fabric, helping to preserve the original appearance of the product.



Figure 1 – Appearance of the device

* Some types of fabrics are sensitive to high temperature steam. Be sure to check the care instructions on the product label before using the device.

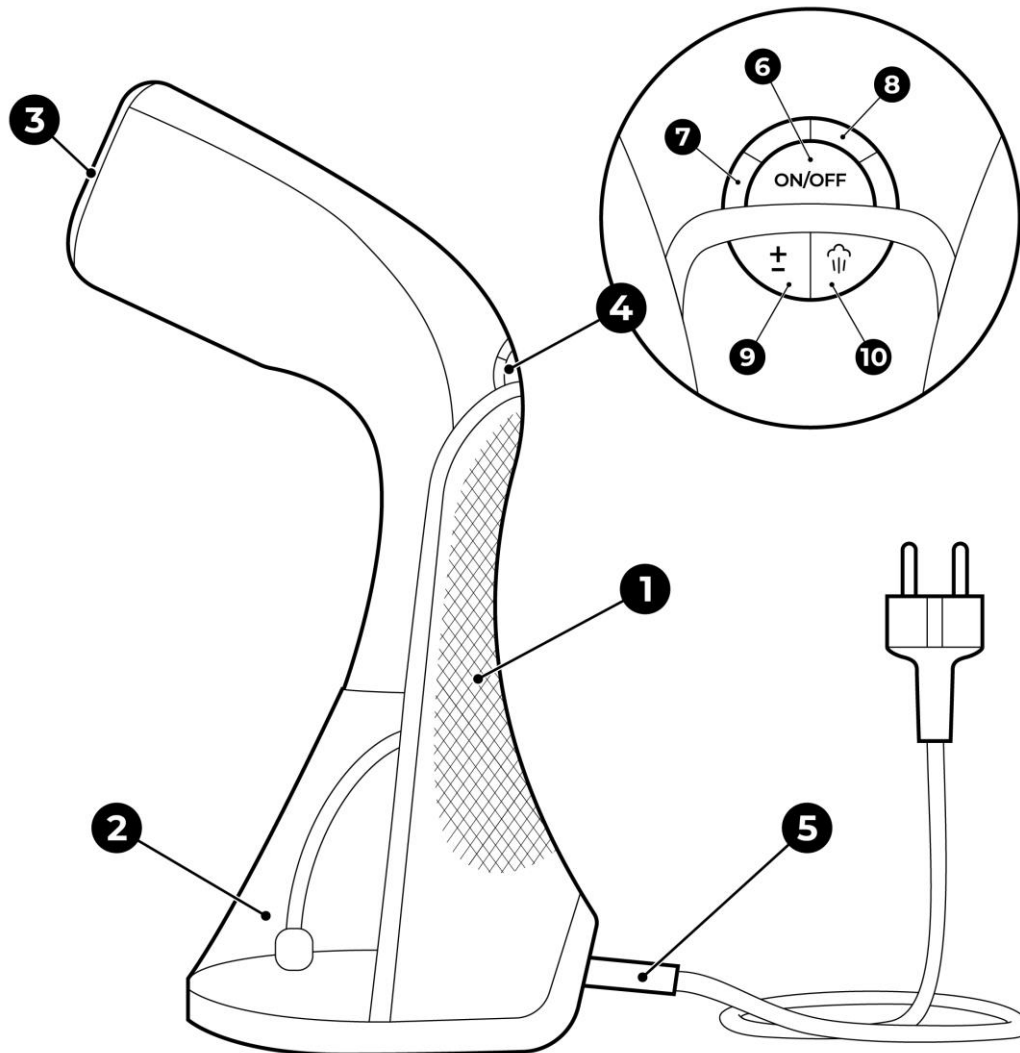

Figure 2 – Device elements

Device elements (see figure 2):

- 1 – knurled handle
- 2 – removable water tank
- 3 – steaming head
- 4 – control panel
- 5 – power cord with movable attachment

Description of the elements 6–10 is given in section 1.5 "Device control panel".

1.2 Technical specifications

Table 1 – Specifications

Parameter	Value
Model	AGS0001 (grey) AGS0003 (black)
Control	Manual
Nominal device parameters	Input voltage: 220–240 V (AC) Input frequency: 50/60 Hz Input power: 1500.0 W (0.5 W max in standby mode)
Water tank	Removable, 0.25 l
Noise level during operation	Up to 65 dB (at 30 cm)
Steam temperature	Up to 160 °C
Preparation time	35 s
Operating modes (steam supply)	Minimum: steam supply 15 ± 5 g/min Medium: steam supply 22 ± 5 g/min Maximum: steam supply 27 ± 5 g/min
Steam pressure	Up to 1 bar
Operating time with a full tank	9–16 min, depending on operating mode
Options for use	Vertical, horizontal steaming
Additional features	Automatic switchover to standby mode Movable power cord hinge (prevents cable twisting and tangling) Splash and leakage protection Overheating protection
Materials	PP plastic
Size (L×W×H)	128×293×201 mm
Weight	Net: 0.95 kg Gross: 1.65 kg
Power cord	1.9 m
Operating conditions	Temperature: +1...+40 °C

Parameter	Value
	Relative humidity: 45–65 % (non-condensing)
Storage conditions	Temperature: -10...+40 °C Relative humidity: 45–65 % (non-condensing)
Service life	2 years
Warranty period	2 years
Certificates	CE, EAC, UA.TR

1.3 Scope of supply

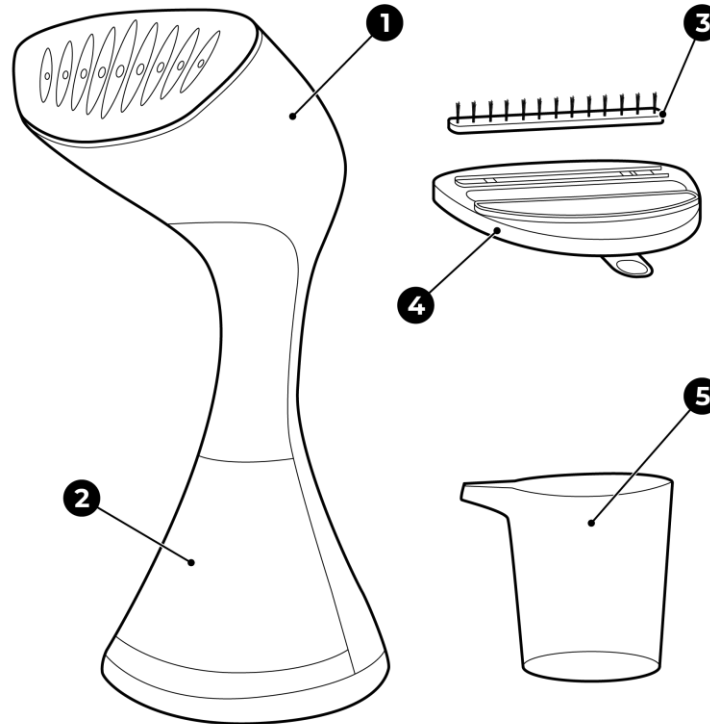

Figure 3 – Scope of supply *

The following items are included with the AENO™ Handheld Garment Steamer (see Table 2).

Table 2 – Scope of supply

Figure	Name	Quantity
1, 2	AENO™ garment steamer with water tank	1 pc.
3, 4	Nozzle with removable brush	1 pc.
5	Measuring cup	1 pc.
6	Quick start guide	1 pc.
7	Warranty card	1 pc.

* The images of accessories are for illustrative purposes only.

1.4 Packaging and labelling

The AENO™ Handheld Garment Steamer comes in individual cardboard packaging sized 155×245×330 mm, containing the full name, markings and main technical specifications of the device, as well as the date of manufacture and the manufacturer's details.

1.5 Device control panel

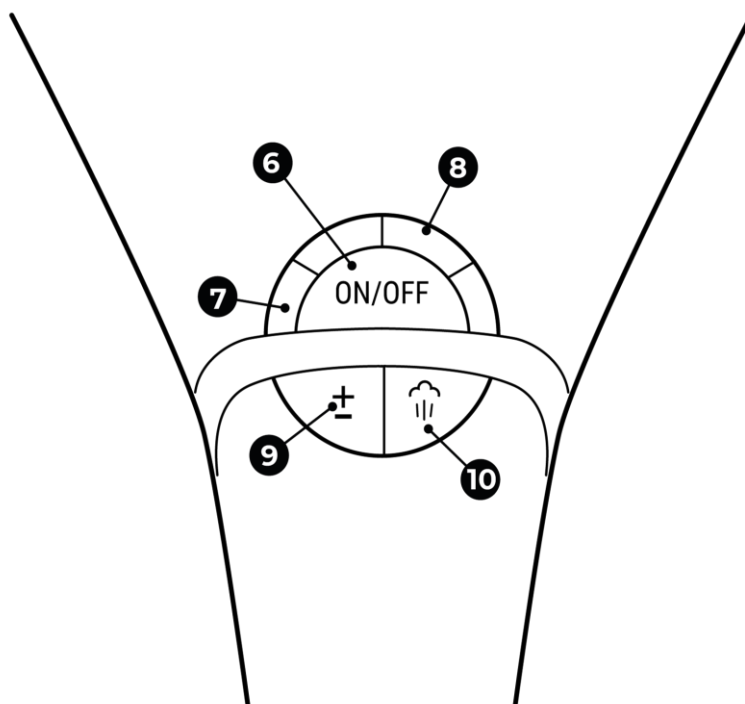









Figure 4 – Device control panel

The control panel of the AENO™ Handheld Garment Steamer has three (3) buttons for operating the device, a standby indicator, and an operating mode indicator.

Table 3 – Buttons and indicators of the device control panel

No.	Symbol	Colour	Status	Description
Standby indicator				
7			off	The device is not connected to the mains or is not turned on
		blue	flashing	The device is connected to the mains but not turned on and is in standby mode
		blue	glowing	The device is connected to the mains and turned on
		blue	slowly flashing (once per second)	The device warns you of the need for self-cleaning
Operating mode indicator				
8		red	flashing	The device is connected to the mains and turned on, it is heating up
		red	glowing	Heating process completed, steam supply available
Buttons				
6	ON/OFF	Device ON/OFF button		
9		Operating mode switch button		
10		Steam on/off button		

NOTE

Do not force the buttons as this may damage the device control panel.

2 Preparing for work and operation

ATTENTION!

When connecting, operating and storing the AENO™ Handheld Garment Steamer, follow the safe use of the device (see "Limitations and warnings").

2.1 Preparing textiles for steaming

Before using the steamer on fabric, check the manufacturer's recommendations on the product label.



Figure 5 – No steaming symbol on the product label

Fabrics not to be steamed are marked with the symbols shown or with symbols similar in meaning.

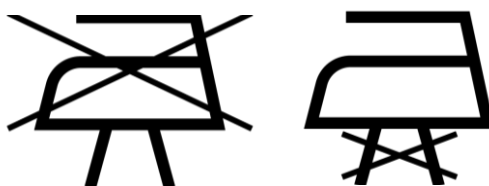

As a rule, such symbols are placed on the labels of products made of fur, wool, or pure polyester. Stiffly shaped garments, such as hats, can also change shape after steaming.

Make sure there is nothing in the pockets of your clothes. Unfold the cuffs, if any.

Place the garment vertically (on a hanger) or onto a horizontal surface that is resistant to high temperature steam (at least 160 °C). Make sure that the steam jet will not touch other fabrics or interior parts that could be damaged by steaming.

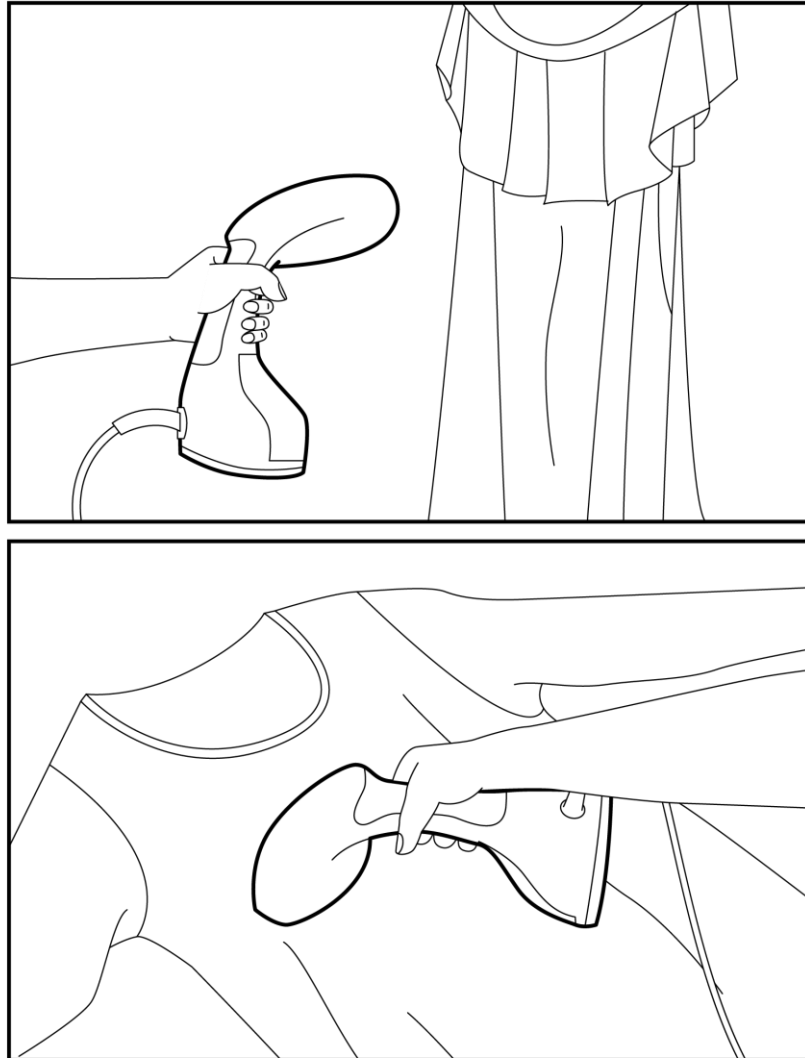

Figure 6 – Horizontal and vertical steaming

Vertical steaming of garments on the hanger avoids excessive moisture in the fabric due to the free space around it.

2.2 Preparing the steamer for operation

Before you start, carefully open the packaging and remove the device and accessories. Wipe the case with a slightly damp cloth dampened with water and wipe it dry.

Remove the water tank by pulling it on the wide part as shown in the figure below.

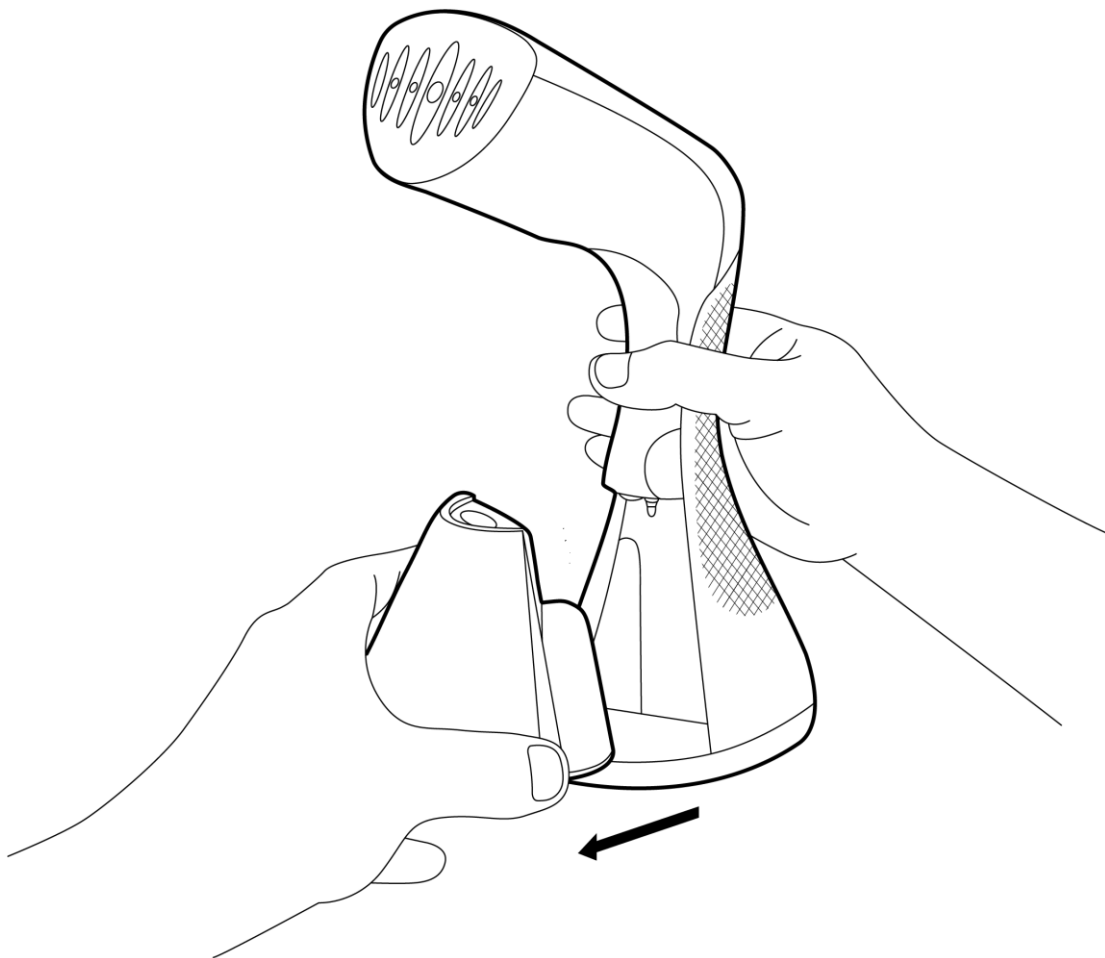

Figure 7 – Removing the tank

Open the silicone plug of the tank opening.

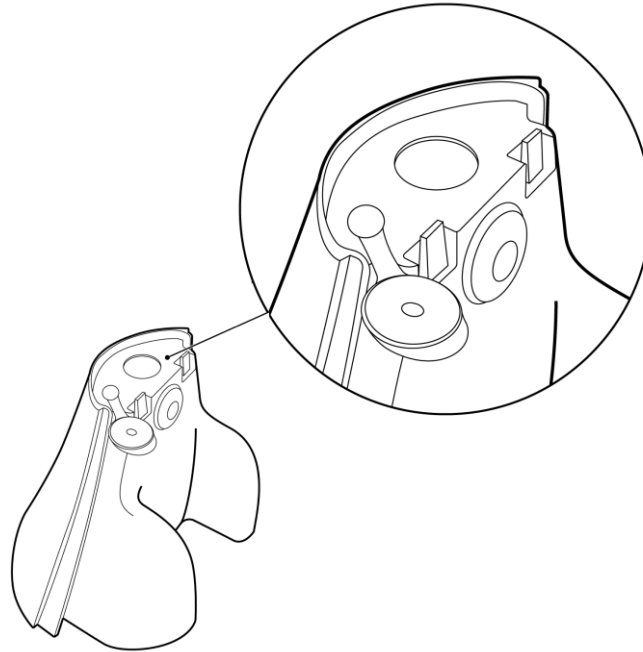

Figure 8 – Tank silicone plug in "open" position

Fill the measuring cup with distilled water, not exceeding the MAX mark.

ATTENTION!

Use only distilled water. Lime scale that forms inside the device when using tap water can cause damage to the product.

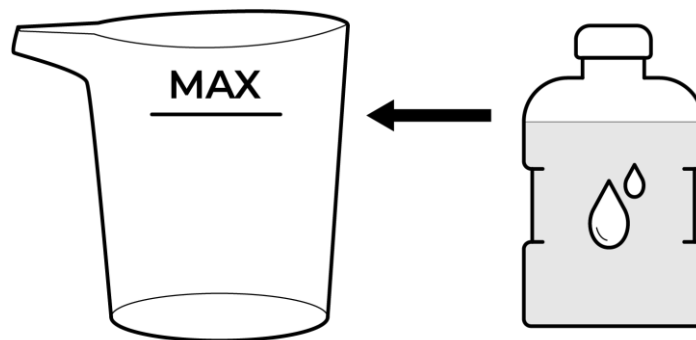

Figure 9 – MAX mark on the measuring cup

Carefully pour the water from the measuring cup into the steamer tank.

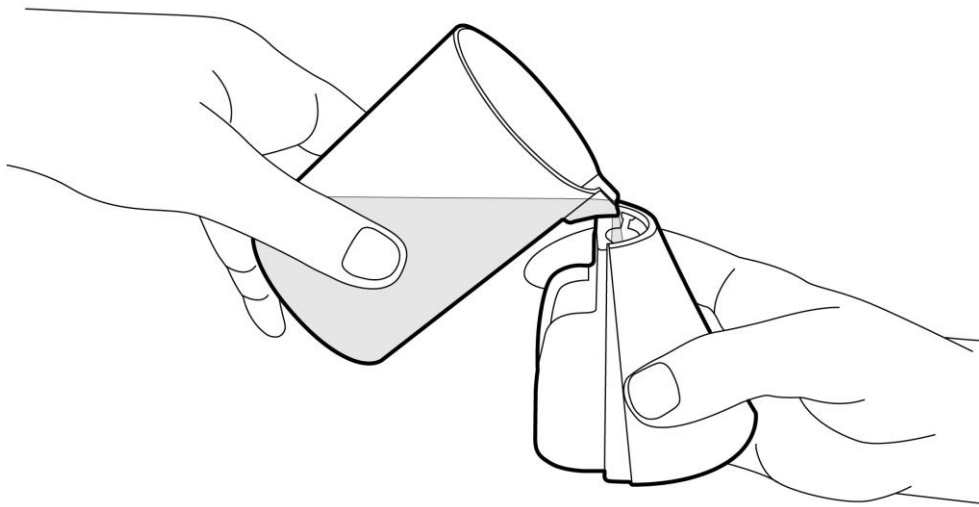

Figure 10 – Filling the tank

Seal the opening in the tank tightly with the silicone plug. Insert the water tank into the steamer.

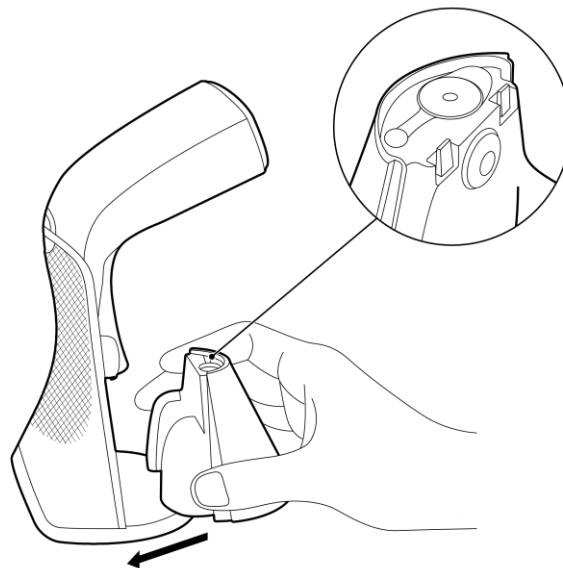

Figure 11 – Tank installation

The two upper lugs **a** on the tank will fit into the slots **b** of the steamer body. When properly installed, a click can be heard.

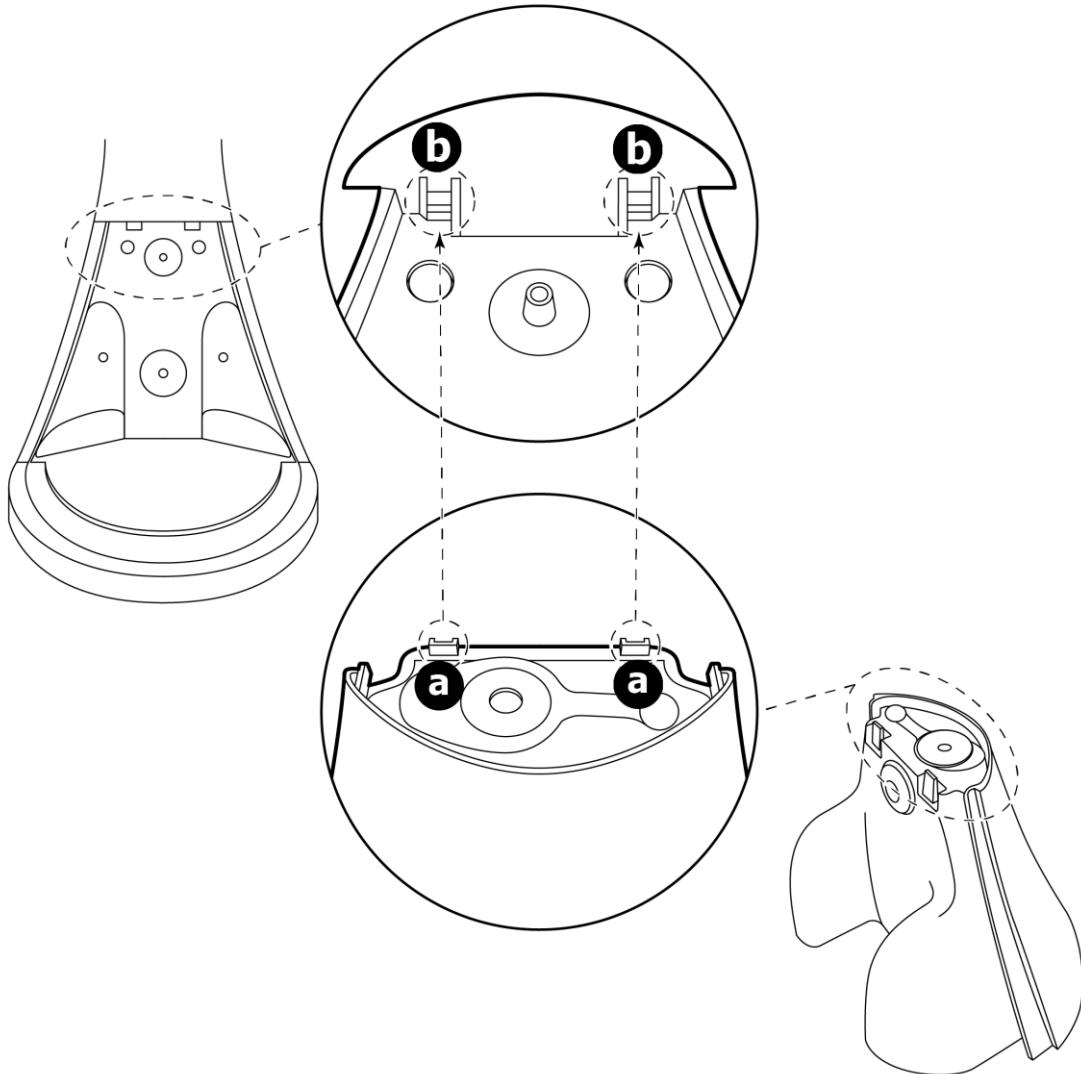

Figure 12 – Tank lugs and slots on the device

Make sure that the tank is securely in place and will not fall out if the steamer is turned horizontally with the tank facing downward.

If necessary, attach a brush attachment to the steaming head.

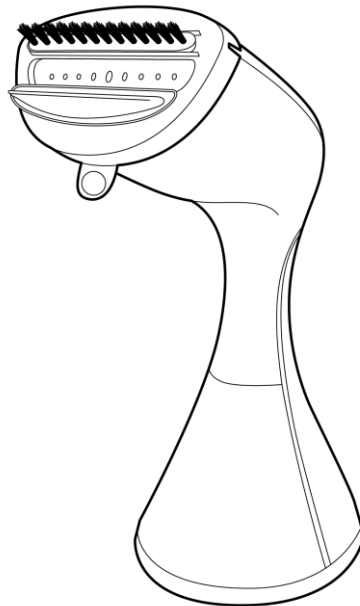

Figure 13 – Nozzle on the steaming head of the device

Prepare clothing or other textiles to be steamed by following the instructions in paragraph 2.1 "Preparing textiles for steaming".

Insert the plug of the power cord into the socket. Press the ON/OFF button (6). The blue standby indicator (7) will light up. The red operating mode indicator (8) will start flashing.

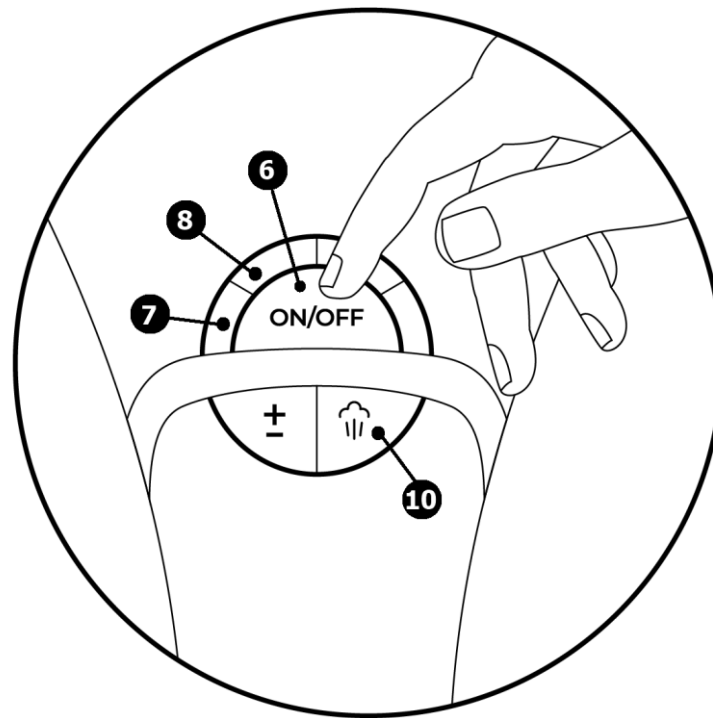

Figure 14 – Pressing the ON/OFF button

Wait about 35 seconds until steam production starts. The steamer must be in an upright position. When the red operating mode indicator (8) starts to glow continuously, it means that the device has heated up sufficiently.

Point the steaming head away from the garment and let the first steam jet out. To do this, press the steam button (10). You will hear the water tank pump crackling and after 2–3 seconds the steam will start to flow. This procedure will remove any dirt or odors that may have built up in the steamer during its manufacture or prolonged storage.

Press the steam button (10) again to stop the flow. The device is now ready to work.

NOTE

Before connecting the device to the mains make sure that the rated voltage indicated in the technical documentation corresponds to the electrical voltage of the socket.

2.3 Operating the device

The AENO™ steamer is equipped with a splash and leakage protection during operation. This allows you to hold the device both horizontally and vertically when steaming.

Start using the device on the seamy side of the garment:

1. Point the steaming head at the garment and press the steam button (10). There is no need to keep the button pressed all the time during steaming.

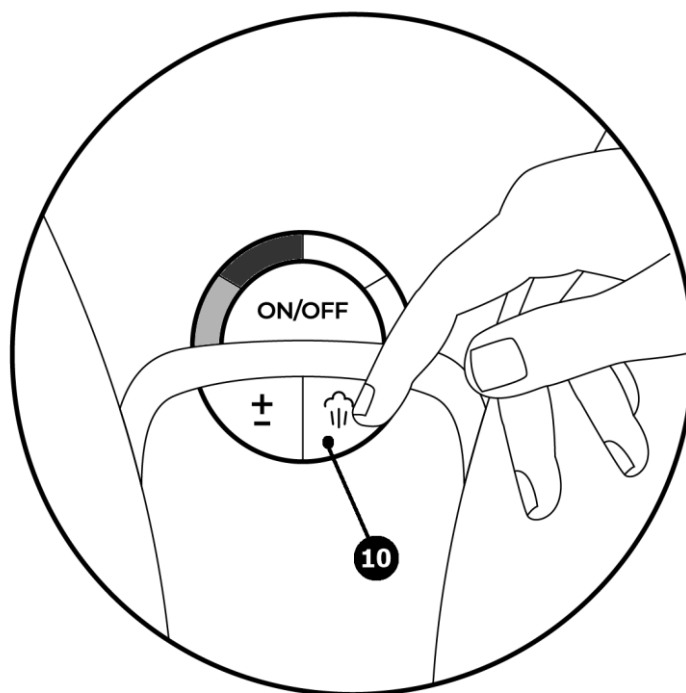

Figure 15 – Pressing the steam button

2. Do not point the steam jet at the same area of the fabric for too long to avoid damaging it.
3. For effective smoothing, the fabric can be slightly stretched, holding it in a place inaccessible to the steam jet, so as not to get scalded.

4. When you have finished steaming the product, press the steam button (10) again (see fig. 15). The steam supply will stop. Place the steamer vertically on a flat, horizontal surface, prepare it for steaming, and steam the next textile.
5. When you have finished steaming all your items, press and hold the ON/OFF button (6) for 3 seconds (see fig. 14) to turn off the device. When the blue standby light (7) (see fig. 14) goes out, unplug the device from the mains.





When the device is turned on, the operating mode is set to minimum steam supply – "Minimal". If necessary, increase the steam supply using the operating mode switch button . To select the best mode for your product, use Table 4, "Operating mode selection".

Table 4 – Operating mode selection

Device operating modes	State of the control panel indicators	Application objects
Minimum operating mode		Delicate fabrics / light pleats
Medium operating mode		Everyday things in cotton, polyester / medium pleats
Maximum operating mode		Dense fabrics / deep pleats

The device can continuously generate steam until it has used up all the water in the tank. This amounts to about 9–16 minutes, depending on the operating mode. If the water in the tank runs out, turn off the device by holding the "ON/OFF" button (6) for 3 seconds (see fig. 14). Wait until the steaming head has cooled down, remove the tank and add water to it according to point 2.2 "Preparing the steamer for operation".

You can touch dense natural fabrics, such as denim, with the steaming head. When using the device on delicate or synthetic fabrics, keep it 1–2 cm away from the surface of the fabric, as the steaming head gets very hot.

When steaming dense and heavy fabrics, it is recommended to use the brush nozzle. The brush nozzle can also be used to clean textiles from hair, lint, wool and dust.

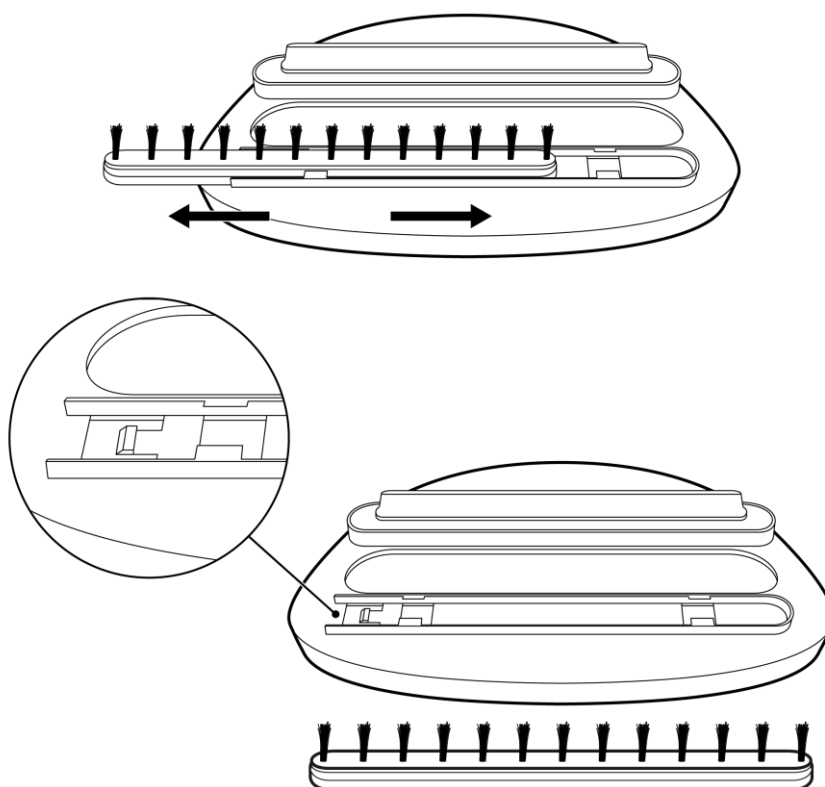

Figure 16 – Removable brush for the nozzle

For ironing pleats on pants, the nozzle can be used without the brush. To remove the brush from the nozzle, slide it toward the open edge of the slot. To put the brush back in place, insert it in the slot and slide it to the opposite side.

After use, clean the device and accessories according to paragraph 3 "Maintenance".

2.4 Auto standby function

The device is equipped with non-use protection – after 15 minutes of inactivity the steamer goes into standby mode.

The blue standby indicator (7) flashes in standby mode. The steaming head of the device starts to cool down.

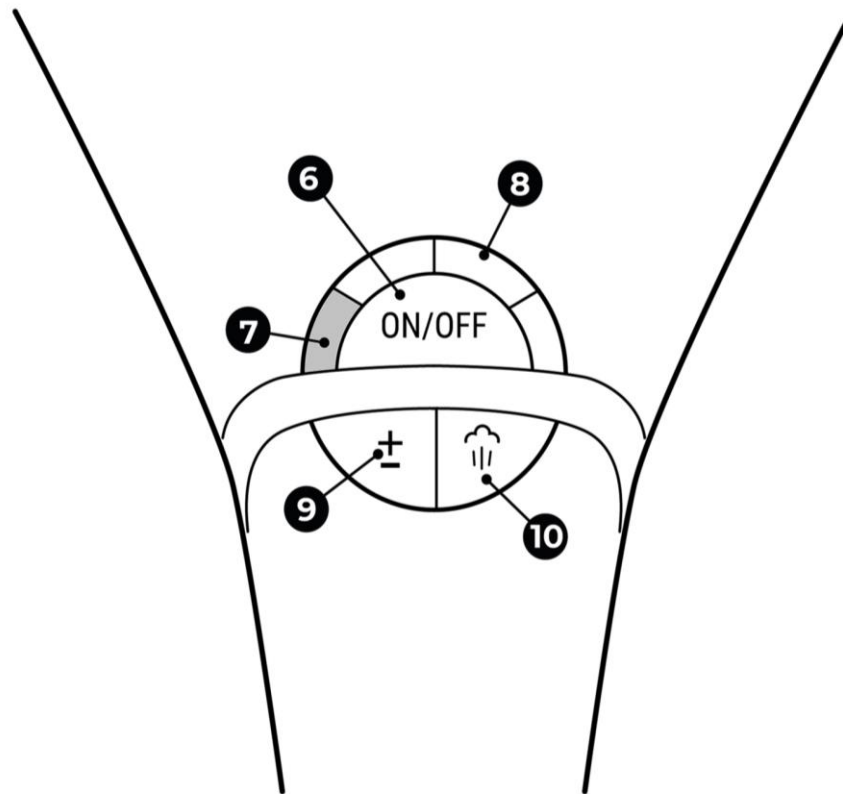

Figure 17 – Device control panel in standby mode

To exit standby mode, press the ON/OFF button again (6).

2.5 Auto shutdown function in case of overheating

The steamer is equipped with an automatic overheat shutoff function. If the temperature of the device rises above a certain value, the automatic shutdown is triggered, all indicators go out, and the steamer stops working. Unplug the device and wait for the steaming head to cool down. After that you can continue to use the steamer according to point 2.3 "Operating the device".

Availability of this function makes working with the device safer.

2.6 Self-cleaning function

Every 5 hours of operation it is recommended to use the device self-cleaning function. The device warns you to start the self-cleaning mode by flashing slowly (once per second) the standby light (7) when the steamer is plugged to the socket.

Fill the tank and place the device close to the water container. Press and hold down the operating mode switch button (9) and the steam button (10) simultaneously for 5 seconds. The device will start to operate in self-cleaning mode.

The red operating mode indicator (8) will flash rapidly. The device will operate at maximum heating and pumping water from the tank for 1 minute. The water from the device should drain into a prepared container.

After 1 minute of self-cleaning, the operating mode indicator (8) will continue to flash rapidly. The tank pump stops working and the heating element dries the device from the inside for 20 seconds. When the cleaning and drying mode is complete, the device will go into standby mode. Then turn off the device by pressing and holding the ON/OFF button and clean the device according to paragraph 3 "Maintenance".

If you do not want to run the device self-cleaning, simply press and hold the steam button (10) for 5 seconds to cancel the warning. After 5 hours of operation, the device will repeat the self-cleaning warning.

3 Maintenance

ATTENTION!

Make sure the device is turned off, unplugged, and **completely cooled down before performing maintenance**. Do not perform maintenance if the device has not cooled down.

To maintain optimum condition and stable operation of the device, it is recommended to perform the following actions:

- clean the device case if there is any pollution;
- clean the water tank and measuring cup after each use of the device;
- clean the brush nozzle after each use.

ATTENTION!

Do not use harsh chemicals, abrasive pastes, polishes or detergents that contain acids or solvents, or metal sponges, which can damage the coating.

Remove the tank and drain the remaining water from it.

Next, proceed to cleaning the device case, accessories and components.

3.1 Cleaning the device case

Use a damp cloth to wipe off dirt and dust on the device case. If heavily soiled, wipe the case with a damp cloth and a few drops of neutral detergent *. Then wipe it dry.

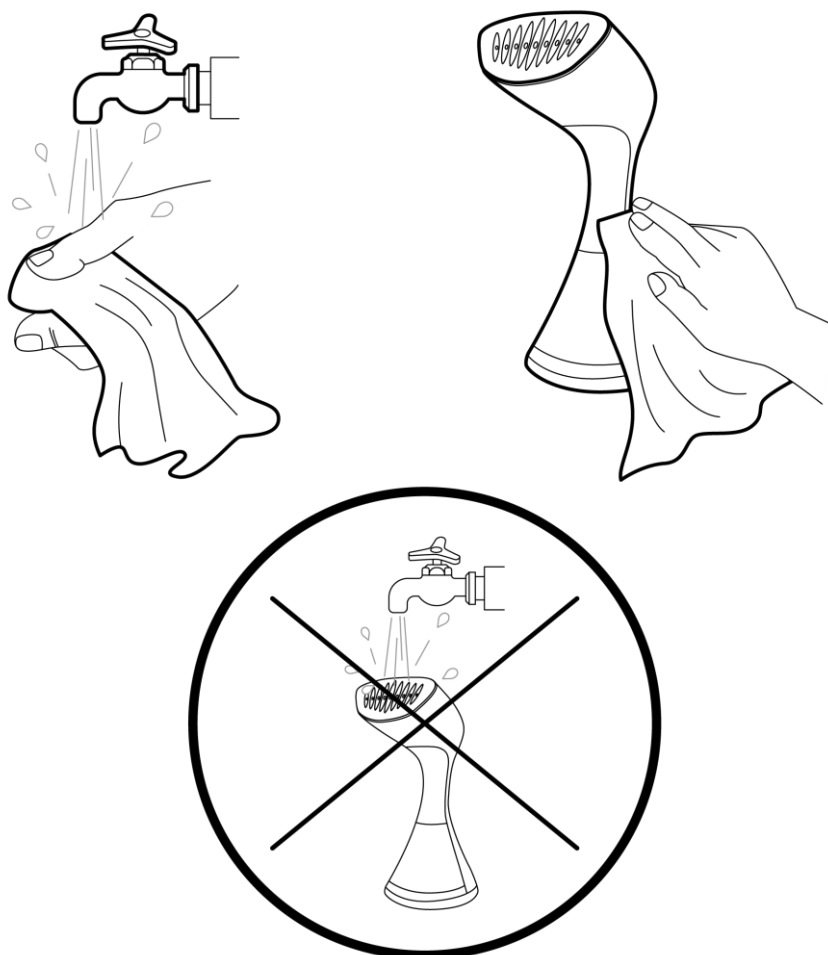

Figure 18 – Cleaning the device case

ATTENTION!

The device **may not** be washed under running water or immersed in water.

* According to publicly available information, detergents with a pH value of 5 to 8 are neutral.

3.2 Cleaning accessories and components

To clean the measuring cup, brush nozzle and water tank, rinse them under running water and wipe them dry.



Figure 19 – Cleaning the water tank and accessories

Leave the tank with the silicone plug open in a warm, dry place for 1–2 hours to allow any residual moisture from inside the tank to evaporate.

4 Warranty obligations

The service life of the device is two (2) years. The manufacturer's warranty for this product is two (2) years from the date of retail sale. The manufacturer's warranty on accessories is two (2) years from the date of retail sale.

You may have other rights under the laws of your country that govern the sale of consumer goods. This limited warranty does not affect such rights.

The manufacturer guarantees proper functioning of all materials, components and assembly of AENO™ products provided that the rules of operation set out in the "User Manual" of the device are followed during the warranty period.

For warranty replacement, the device must be returned to the retailer, along with the receipt verifying the purchase.

The following are not considered defects:

- the smell of new plastic or rubber during the first days of operation;
- change of colour shade, gloss of equipment parts during operation;
- noises (not exceeding the sanitary norms) related to the operating principles of the individual components of the product, namely:
 - fans;
 - water valves;
 - electrical relays;
 - electric motors;
 - belts;
 - compressors;
- noises caused by natural wear and tear (ageing) of materials, namely:
 - crackling during heating/cooling;
 - creaks;
 - slight tapping noise in the moving mechanisms;
- need to replace consumables and wear parts that have become unusable as a result of their natural wear and tear.

4.1 AENO service centers

For a list of cities where the manufacturer's service is available, visit **aeno.com**.

4.2 Warranty service procedure

If you discover a suspected fault or defect in the device, you should contact an authorized service centre before the warranty period expires and provide the following information:

1. A device with an alleged fault or defect.
2. Original document confirming the purchase.

In the absence of an authorized service center, the customer should contact the store where the device was purchased.

Warranty service is not available for:

- adjustment, cleaning and other care of the product as specified in this user manual;
- replacement of consumables (batteries, filters, light bulbs, dust bags, etc.) as specified in this document.

4.3 Limitation of liability

Products with manufacturing defects are subject to warranty service during the warranty period. In this case, the warranty period is extended by the duration of the repair.

AENO™ products are not eligible for free warranty service if the following damages or defects are found:

- damage caused by force majeure, accidents, negligence, intentional or careless actions (omissions) of the buyer or third parties;
- damage caused by the effects of other objects, including but not limited to exposure to moisture, dampness, extreme temperatures, or environmental conditions (or if they change drastically), corrosion, oxidation, ingress of food or liquid and exposure to chemicals, animals, insects, and their products of vital activity;
- if the device (accessories, components) has been opened (the seals are broken), altered or repaired by anyone other than an authorized service centre, or with unauthorized replacement parts;
- defects or damage caused by improper use, misuse, including use contrary to the operating instructions;
- defects caused by normal wear and tear, including bags, cases, battery packs, or user manuals;

- if the serial number (factory stickers), manufacturing date or model name on the device have been removed, erased, damaged, altered or is illegible in any way;
- in case of violation of the rules and conditions of operation, as well as the installation of the device, set forth in the operating manual;
- cracks and scratches as well as other defects resulting from transportation, operation by the purchaser or negligent handling on his part;
- mechanical damage that occurred after the device was handed to the user, including the damage caused by sharp objects, bending, compressing, dropping, etc;
- damage caused by nonconformity with the standards of power supply, telecommunication and cable networks or similar external factors.

This limited warranty is the exclusive and sole warranty provided and is in lieu of all other express and implied warranties. The manufacturer makes no warranty, either express or implied, beyond the description contained herein, including an implied warranty of merchantability and fitness for a particular purpose. It remains at the discretion of the purchaser to use a faulty, defective and unacceptable device. The manufacturer shall not be liable for damages to other property due to any defects in the device, loss of use of the device, loss of time, or for any special, incidental, indirect or consequential damages, punitive damages and losses, including but not limited to commercial damages, loss of profits, loss of confidential or other information, losses due to business or operational interruption due to the device being found to be defective, malfunctioned or inappropriate for use.

NOTE

The manufacturer does not produce equipment for the sphere of "vital tasks". Devices for "vital tasks" include life support systems, medical equipment, medical devices used for implantation, commercial transportation, nuclear equipment or systems, and any other applications where equipment failure could result in injury or death of a person, or damage to property.

5 Storage, transportation and disposal

The product can be transported at any distance by any type of transport that ensures the safety of the device, in accordance with the rules of cargo transportation operating on a particular type of transport. Do not allow water to get on the packaging and/or the product.

Before storing the device, be sure to clean it and allow it to dry completely. Store the device in a dry, closed room, out of the reach of children and away from heating devices, excluding direct sunlight and moisture. The device must be placed in its original packaging for long periods of storage. If these requirements are not met, ASBIS does not guarantee that the device retains its declared parameters due to possible degradation of its components, accumulation of dust, moisture or negative effects of other factors.

In accordance with the Waste Electrical and Electronic Equipment (WEEE) regulations, all electrical and electronic products must be collected separately at the end of their service life and cannot be disposed of together with unsorted municipal waste.

Parts of unusable devices must be separated and sorted by material type. Proper collection, recycling and disposal of these devices will help avoid potential environmental and health impacts from the harmful substances they contain.

The device must be taken to a local recycling center for disposal. Disposal is carried out in accordance with the applicable laws and regulations of the relevant country.

For more information on the recycling of this device, contact your municipal waste disposal service.

If the user cannot take the device to a specialised collection and recycling facility, it can also be handed over to a hardware and building supply shop, the local department of the governmental emergency management agency, or a similar institution. Do not dispose of the device together with unsorted municipal waste, as this would be harmful to the environment.

6 Other information

Manufacturer details

Name	ASBISc Enterprises PLC
Address	Iapetou, 1, Agios Athanasios, 4101, Limassol, Cyprus
Contact details	Tel.: +357-25857000, asbis.com

Importer details

Name	ASBISc Enterprises PLC
Address	Iapetou, 1, Agios Athanasios, 4101, Limassol, Cyprus
Contact info	Tel.: +357-25857000, asbis.com

For information about warranty and claims organizations, visit **aeno.com**, section "Service & Warranty".

Information about obtained certificates and declarations of conformity

Directives, certificates and regulations	Declaration of Conformity to Directives 2014/30/EU, 2014/35/EU, 2009/125/EU of 5 November 2021.
	Declaration of Conformity to Regulation 1275/2008/EU of 5 November 2021.
	Declaration of Conformity to Regulation 801/2013/EU of 5 November 2021.
	Declaration of Conformity to RoHS Regulation 2011/65/EU of 5 November 2021.
	Declaration of Conformity to DSTU EN 60335-1:2017 (EN 60335-1:2012; A11:2014; AC:2014; A13:2017, IDT; IEC 60335-1:2010, MOD) of 9 November 2021.
	Declaration of Conformity to DSTU EN 60335-2-85:2015/Amendment No.1:2015 (EN 60335-2-85:2003/A1:2008, IDT) of 9 November 2021.
	Declaration of Conformity to DSTU EN 62233:2008 of 9 November 2021. Certificate No. EAEU RU C-CY.HA46.B.03118/22 of 16 March 2022.

7 Troubleshooting

Table 5 shows typical problems that occur when connecting and configuring the device, and possible ways to fix them

Table 5 – Typical problems and solutions

No.	Problem	Possible causes	Solution
1	The steamer does not heat up	The device is not connected to the mains or is not turned on.	Make sure that the device is turned on, the plug is connected to the socket, and the socket is in good condition. Make sure you have pressed the ON/OFF button.
2	The steamer does not produce steam	No water in the tank	Unplug the device and fill the tank with water
		The tank is incorrectly installed	Install the water tank according to paragraph 2.2
3	Water drips from the steaming head or runs out of the tank	The steamer is not heated to the desired temperature	Wait (about 35 seconds) for the red operating mode indicator (8) to glow continuously. Up to this moment, the steamer should be in upright position
		Silicone plug of water tank is not properly sealed	Remove the tank, close the plug tightly and reinstall the tank according to paragraph 2.2

ATTENTION!

If none of the possible solutions solves the problem, contact your supplier or service centre. Please do not disassemble or attempt to repair the device on your own.

8 Glossary

Class I	Class of electrical safety in which electric shock protection is provided by basic insulation and the connection of exposed conductive parts accessible to contact with the protective conductor of the fixed wiring. The device must be connected to a special socket with a grounding contact
PP plastic	Polypropylene, food grade plastic High strength and heat resistance, safe in contact with all food products
WEEE	Waste Electrical and Electronic Equipment means used electrical or electronic equipment, including all components, subassemblies, consumables that are part of the equipment at the time it is taken out of service (including supplied batteries / rechargeable batteries (if any), components containing mercury, etc.)

A E N O

C R E A T I N G T H E F U T U R E